

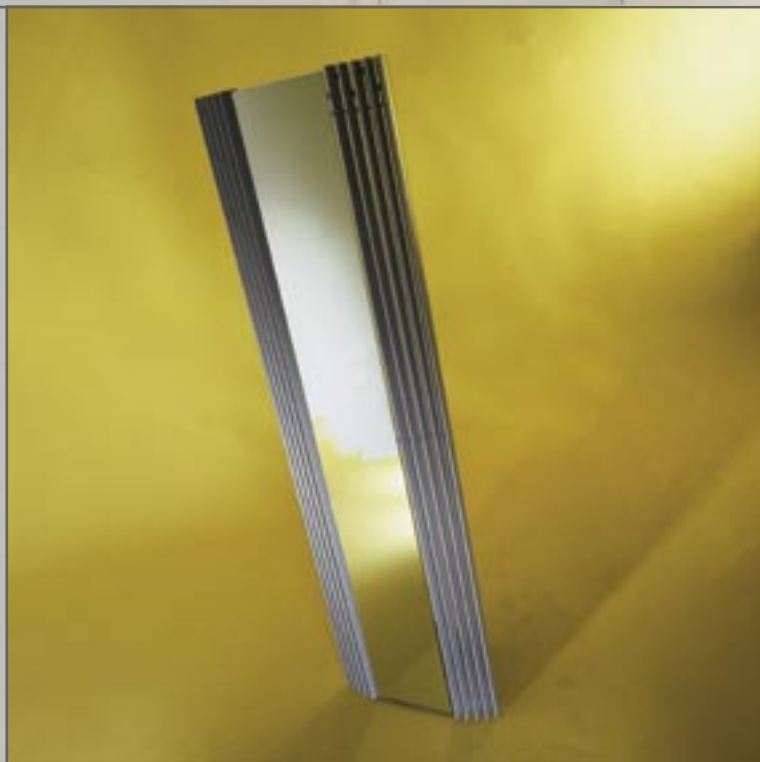

Iguana > Visio

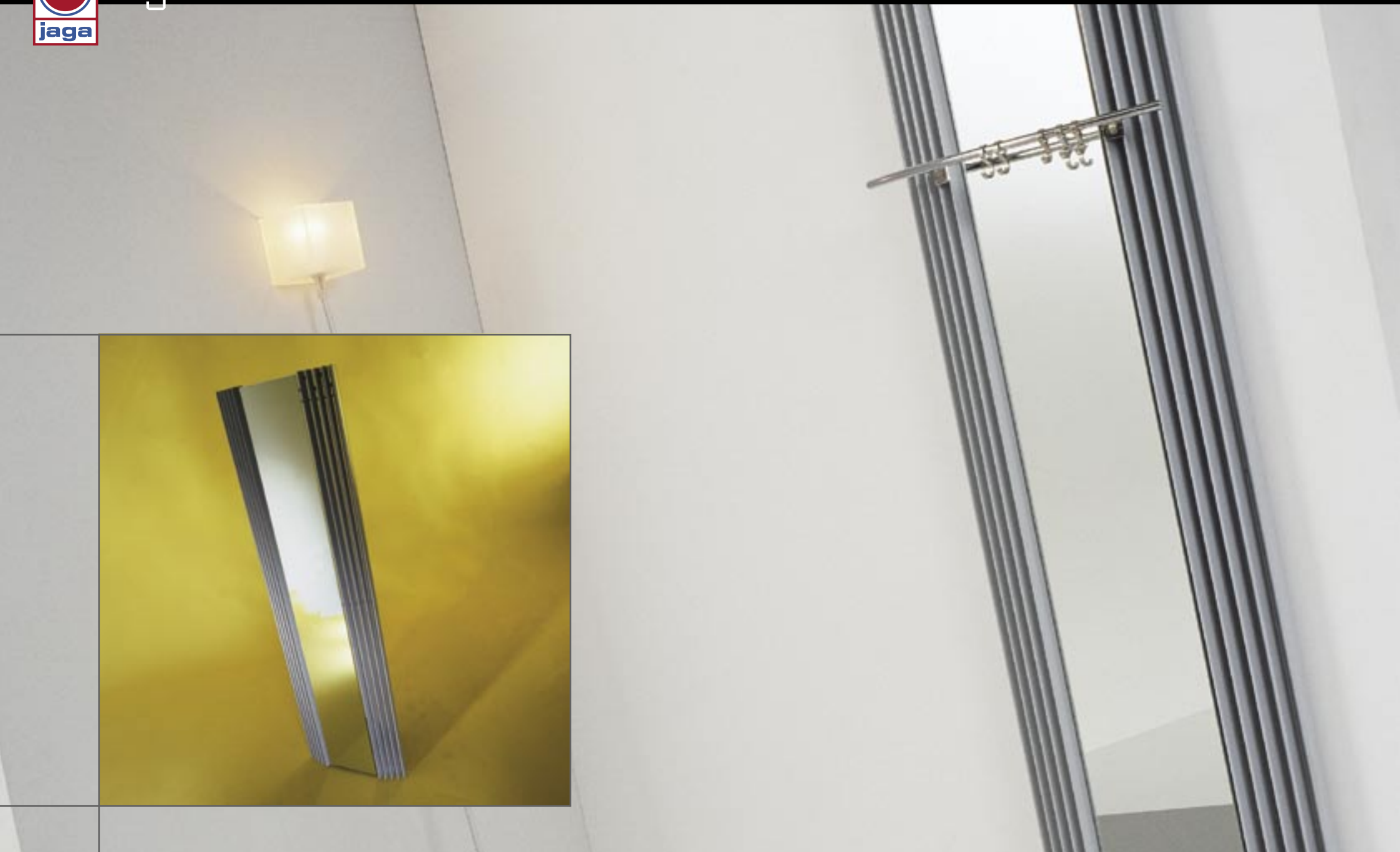



Iguana > Visio

RADIATOR AND MIRROR IN ONE!

Iguana is a visually attractive design radiator, with a compact and refined appearance. Iguana symbolises the essentials of heating: the rhythmic succession of sun rays and nothing more. No collectors, no technical stunts. Thanks to the simple aesthetics and natural rhythm, the symbolic value of Iguana is unique.

COLOURS

Standard colours without surcharge:

- > sandblast grey metallic 001
- > white 301 (RAL 9010 satin)
- > white 333 (RAL 9016 satin)

Other colours:

- > see colour chart

The Iguana Design-Awards:



DIMENSIONS

VISW

Visio Wall

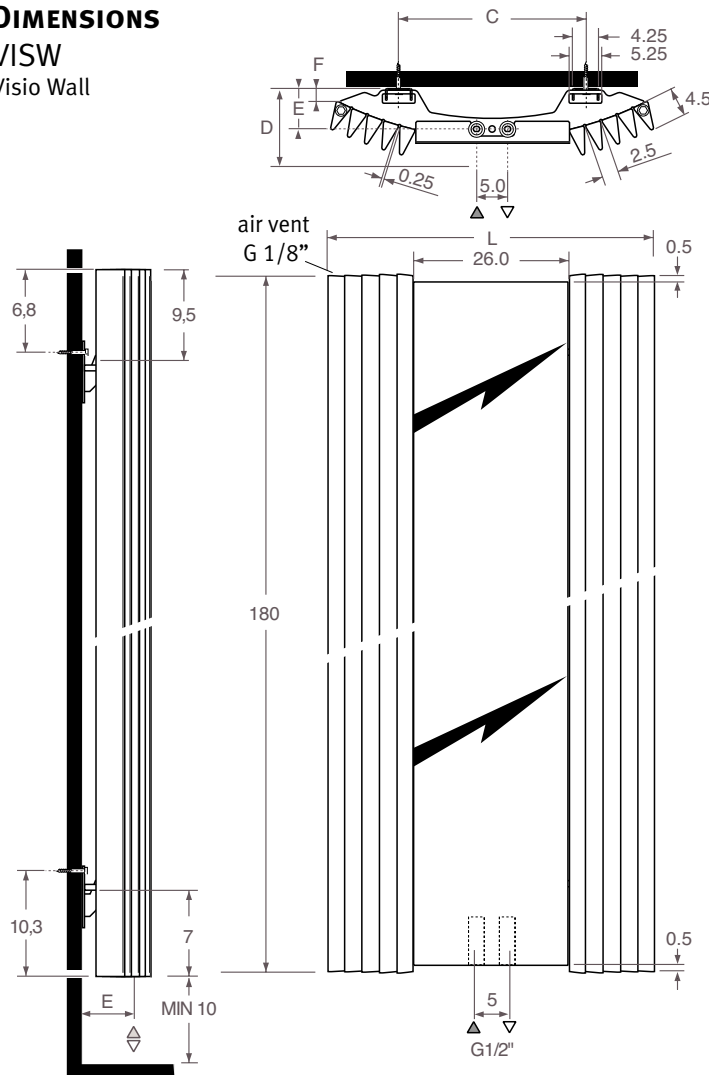

DIMENSIONS IN CM

L	51.9	62.5	73.3
C	30.0	40.0	50.0
D	10.5	11.0	12.5
E	6.5	6.0	7.5
F	2.0	2.8	2.3

CONNECTIONS

TWO PIPE

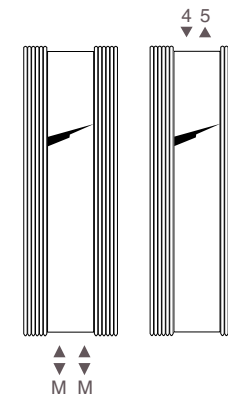

STANDARD CONNECTION:
CODE MM

TOP END CONNECTION:
CODE 45 OR 54

(1° number > flow)

When ordering a top end connection, no insert pipe should be ordered. Air vents should be positioned on the central heating pipes.

Ordering code: specify code 45 or 54 instead if MM, no surcharge.

ONE PIPE:

The standard radiator can be connected to a one pipe system with connection sets 41 or 42. With a maximum of 2 radiators per heating ring.



Iguana > Visio > Options

OPTIONS VISIO

LARGE TABLET in beech veneer

Code	For Visio	L
9087.020529	L 51	53
9087.020543	L 62 > 73	54



SMALL TABLET in beech veneer

Code	For Visio	L
9087.021480	L 51	48
9087.021512	L 62 > 73	51



TOWEL RAIL chrome-plated aluminium

Code	For Visio	L
9087.023550	L 51	55
9087.023656	L 62 > 73	66



HAT RACK chrome-plated aluminium

Code	For Visio	L
9087.024550	L 51	55
9087.024656	L 62 > 73	66



DIMENSIONS OPTIONS

LARGE TABLET

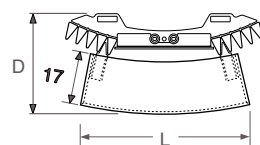

Visio	29	41	51	62	73	83
L	-	53.0	53.0	54.0	54.0	54.0
D	-	28.9	30.5	30.0	31.5	33.5

SMALL TABLET

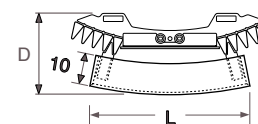

Visio	29	41	51	62	73	83
L	-	48.0	48.0	51.0	51.0	51.0
D	-	21.9	23.5	23.0	24.5	26.5

TOWEL RAIL

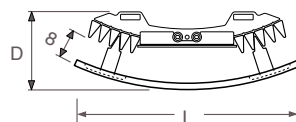

Visio	29	41	51	62	73	83
L	-	55.0	55.0	66.0	66.0	66.0
D	-	18.8	20.4	19.9	21.4	23.4

HAT RACK

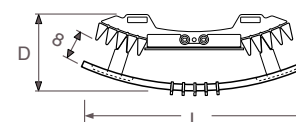

Visio	29	41	51	62	73	83
L	-	55.0	55.0	66.0	66.0	66.0
D	-	18.8	20.4	19.9	21.4	23.4



Product descriptions > Iguana

IGUANA

Material

Consists of vertical triangular steel radiation pipes, welded on steel positioning brackets. The radiation pipes are hydraulically connected by means of steel bends. Suitable for central heating.

Finish

The radiators are sandblasted, degreased, phosphated, electrostatic lacquered with epoxy polyester powder and enamelled at 200°C. This high-quality finishing offers optimum resistance against scratching and is easy to maintain.

Thickness of the lacquer coating: min. 60µ

Test pressure: 9 bar

Work pressure: 6 bar

Colour

The radiator is lacquered in the colour [sandblast grey metallic 001](#) / [white \(RAL 9010\)](#) / [white \(RAL 9016\)](#) / [other \(see colour chart\)](#)

IGUANA APLANO

The Iguana Aplano consists of triangular vertical radiation pipes welded on steel positioning brackets. The radiation pipes are hydraulically connected by means of steel bends, mounted next to each other in a straight surface. Supplied with wall brackets and 2 air vents G 1/8". Central connection, standard for 2 pipe.

IGUANA ARCO

The Iguana Arco consists of triangular vertical radiation pipes welded on steel positioning brackets. The radiation pipes are hydraulically connected by means of steel bends, placed next to each other in a curved line. Supplied with wall brackets and 2 air vents G 1/8". Central connection, standard for 2 pipe.

IGUANA VISIO

The Iguana Visio consists of triangular vertical radiation pipes welded on steel positioning brackets. The radiation pipes are hydraulically connected by means of steel bends, placed next to each other in a curved line with an open space in which a rectangular mirror in the full length of the radiator has been placed. Mirror with a cut edge all around, dimensions 26 cm x 179 cm.

Supplied with wall brackets and 2 air vents G 1/8". Central connection, standard for 2 pipe.

IGUANA CORNER

The Iguana Corner consists of triangular vertical radiation pipes welded on steel positioning brackets. The radiation pipes are hydraulically connected by means of steel bends, placed next to each other in a quarter circle. Suitable for central heating. Supplied with wall brackets and 2 air vents G 1/8". Central connection, standard for 2 pipe.

IGUANA CIRCO WALL MOUNTED MODEL

The Iguana Circo wall mounted model consists of triangular vertical radiation pipes welded on steel positioning brackets. The radiation pipes are hydraulically connected by means of steel bends, placed next to each other in half a circle. Supplied with wall brackets and 2 air vents G 1/8". Central connection, standard for 2 pipe.

IGUANA CIRCO FREE-STANDING

Consists of 2 parts with triangular vertical radiation pipes, placed next to each other in half a circle, to be mounted on the supplied round suspension column. After mounting, the radiation pipes will form a full circle. Standard for 2-pipe connection to the floor. Supplied with suspension column and brackets, 4 air vents G 1/8", all pieces for hydraulic connection and connecting pieces and guard with thermostatic valve and return valve for invisible connection.

IGUANA CIRCO PILLAR COVER

Consists of 2 parts with triangular vertical radiation pipes, placed next to each other in half a circle, to be mounted around a construction column. After mounting the radiation pipes will form a full circle. Standard for 2-pipe connection to the floor. Supplied with suspension brackets, 4 air vents G 1/8", all pieces for hydraulic connection and connecting pieces and guard with thermostatic valve and return valve for invisible connection.

OPTIONS

All options have the same radius as the radiator. They can also be ordered and fitted afterwards.

FOR IGUANA ARCO, VISIO, CORNER & APLANO:

- > Towel rail and fixings in chrome-plated aluminium.
- > Hat rack and fixings in chrome-plated aluminium. Including 5 coat hooks.
- > Small tablet in beech veneer with chrome-plated fixings. Tablet width: 10 cm.
- > Large tablet in beech veneer with chrome-plated fixings. Tablet width: 17 cm.
- > Deco connection sets and valves 2 pipe.
- > Deco Pro connection sets and valves 2 pipe or one pipe.

FOR IGUANA CIRCO WALL MOUNTED MODEL:

- > Towel rail and fixings in chrome-plated aluminium.
- > Hat rack and fixings in chrome-plated aluminium. Including 5 coat hooks.
- > Small tablet in beech veneer with chrome-plated fixings. Tablet width: 10 cm.
- > Large tablet in beech veneer with chrome-plated fixings. Tablet width: 17 cm.
- > Deco connection sets and valves 2 pipe.
- > Deco Pro connection sets and valves 2 pipe or one pipe.
- > Guard with thermostatic valve, return valve for invisible connection to the wall

or to the floor. Floorboards need to be removed for the guard.

FOR IGUANA CIRCO FREE-STANDING AND PILLAR COVER:

- > Towel rail and fixings in chrome-plated aluminium.
- > Hat rack and fixings in chrome-plated aluminium. Including 5 coat hooks.
- > Small tablet in beech veneer with chrome-plated fixings. Tablet width: 10 cm.
- > Large tablet in beech veneer with chrome-plated fixings. Tablet width: 17 cm.
- > Table in beech veneer with supports and fixings in chrome-plated aluminium.

HOW TO INSTALL

The building services engineer chooses the heating elements considering the following conditions:

- > A heat output calculation according to the standard.
- > Tables of heat outputs and dimensions for Iguana [Aplano](#) / [Arco](#) / [Visio](#) / [Corner](#) / [Circo wall mounted](#) / [Circo free-standing](#) / [Circo pillar cover](#) radiators according to EN 442
- > The radiators will be mounted [to the wall](#) / [on the supplied round suspension column](#) / [round a construction column](#) with accessory brackets
- > The specially designed [thermostatic connection sets](#) / [thermostatic Jaga Deco](#) / [Jaga-Pro valves](#) / [manual Jaga Deco valves](#) can be connected to [plastic central heating service pipes](#) / [RPE/ALU. tube](#) / [copper tube](#) / [steel pipe](#).
- > [Jaga thermostatic heads](#) / [Jaga Deco thermostatic heads chrome](#) / [Jaga Deco thermostatic heads chrome/white](#) / [Jaga Comap thermostatic heads silver](#) / [not to be](#) / [to be](#) fitted.

