



# IGUANA ANGULA PLUS

Warmth with a symbolic value. Inspired by a child's drawing, an interpretation of the brightly shining sun, transformed into a fully functional work of art.

A radiator around the corner. Great capacity in a small space. A special solution, both energy-wise and aesthetically!



Top 10  
Design  
Award  
Winner  
2000

ISH 1999  
DESIGN PLUS  
Senior - History - Plus

IGUANA ANGULA traffic white 333



*EyeCatchers*

From design to art

IGUANA ANGUULA PLUS



# IGUANA ANGULA PLUS

DIMENSIONS (in cm)



## ANGULA PLUS / CR

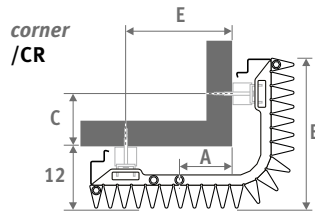

## ANGULA PLUS / CL

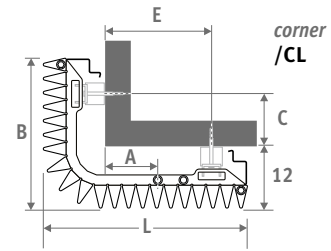

L	A	B	C	E
40.0	10.5	29.0	10.0	21.0
45.5	13.0	34.5	15.5	26.5
51.0	16.0	40.0	21.0	32.0

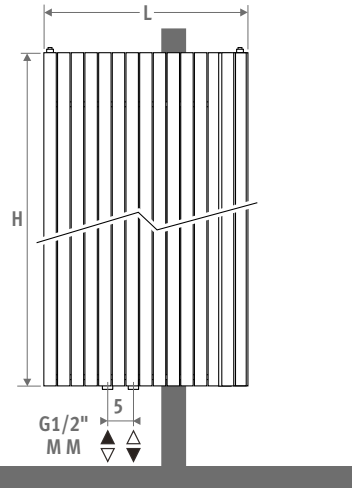
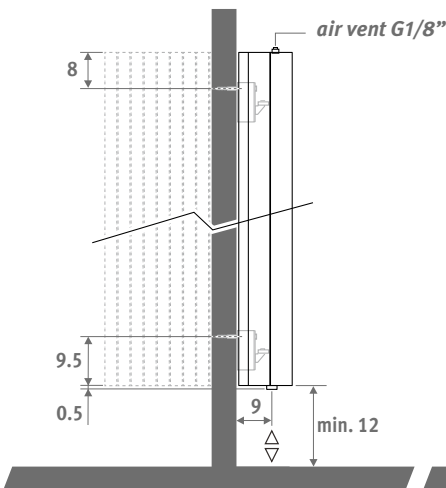

### DELIVERY

- central connection MM underneath
- wall fixing
- 2 chrome-plated air vents G1/8"
- 2 side panels

### COLOURS

Environmentally friendly, scratch-resistant, high UV resistant powder coating.

Standard colours:

- traffic white RAL 9016 (333), smooth satin matt
  - sandblast grey (001), fine texture metallic
- Other colours: see colour chart.

### CONNECTION

Top connection:  
specify code 45 or 54 instead of MM (1° number is flow).

No insert pipe should be ordered. Provide an air vent on the central heating pipework.

One pipe connection:  
connection sets 41, 42, 48 or 49.  
Max. 2 radiators per heating ring.

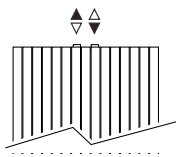



### CONNECTION SETS

To guarantee the output of the Iguana models and to limit the pressure drop, Jaga recommends the use of 15/1 minimum diameter pipes.

#### Connection set to the wall with a Deco-Pro valve

TRV head and sleeve couplings included.



<b>set 48</b>	<b>BRUSHED STAINLESS STEEL</b>	€
	CODE.PW3.PS.1...	222,30
<b>set 41</b>	<b>CHROME</b>	€
	CODE.PW3.AW.1...	142,70
	CODE.PW3.AC.1...	156,30

fill in sleeve coupling code

Precision metal tube 15/1	115
Precision metal tube 16/1	116
Precision metal tube 18/1	118
RPE/ALU tube 16/2	316
RPE/ALU tube 18/2	318

#### Other connections:

See chapter "Connection sets and valves" for all connection options and technical information

*Iguana+*  
COLLECTION  
40% more warmth

# IGUANA ANGULA PLUS



code height length colour conn. corner  
**ANPW . 180 040 . XXX /MM /XX**  
 fill in colour code —┐  
 CL or CR —┘

	Watts 75/65	Watts 55/45	€ st. colour	€ other
<b>L H 180</b>				
040	1745	873	1152,40	1382,90
046	2078	1040	1340,60	1608,80
051	2410	1206	1528,30	1834,00
<b>L H 192</b>				
040	1823	918	1224,90	1469,90
046	2170	1093	1410,80	1693,00
051	2517	1267	1596,80	1916,20
<b>L H 220</b>				
040	1978	1010	1366,00	1639,20
046	2355	1203	1562,80	1875,30
051	2732	1396	1760,60	2112,70
<b>L H 240</b>				
040	2066	1066	1440,70	1728,80
046	2460	1270	1648,70	1978,50
051	2854	1473	1855,90	2227,20

EN442 output at 20°C room temperature