

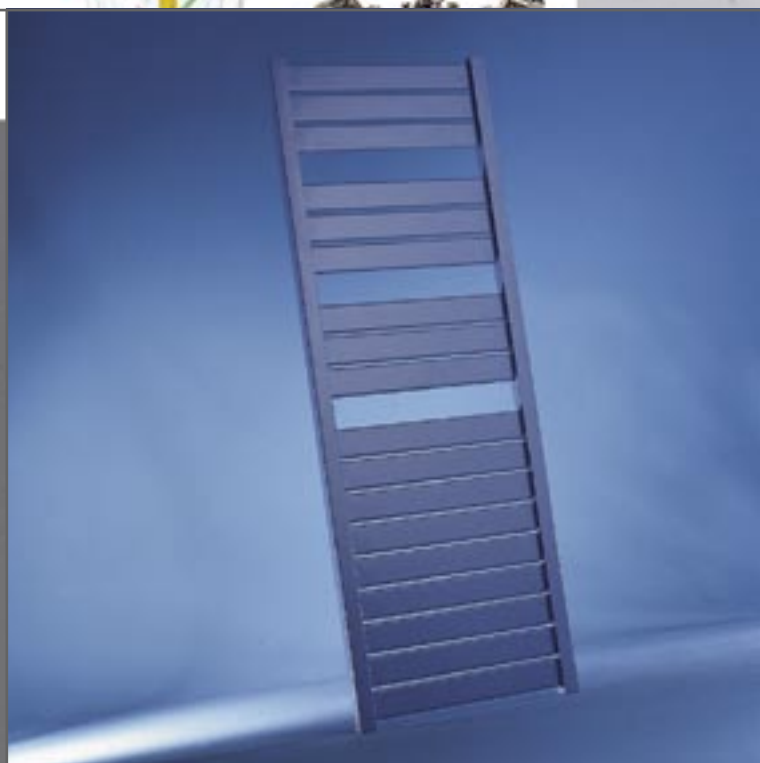

Sani Panel





Sani Panel

EXTRA WARMTH AND FUNCTIONALITY FOR EACH KITCHEN AND BATHROOM

Jaga presents you with a beautiful and attractive design with high heat output, providing comfort and warmth.

Choose the towel rail as your main source of heat, warming up the whole room, or choose a smaller version just to keep your towels warm and dry.

Delicately integrated in soft pastel tones, as a colourful eye-catcher, or as a design object in sandblast grey.

All Jaga products are lacquered and treated without active solvents in an environmentally friendly way.

COLOURS

Standard colours without surcharge:

- > white (233) RAL 9016 glossy
- > white (201) RAL 9010 glossy
- > sandblast grey metallic 001

Other colours: see colour chart

DIMENSIONS

SPAW
Sani Panel Wall

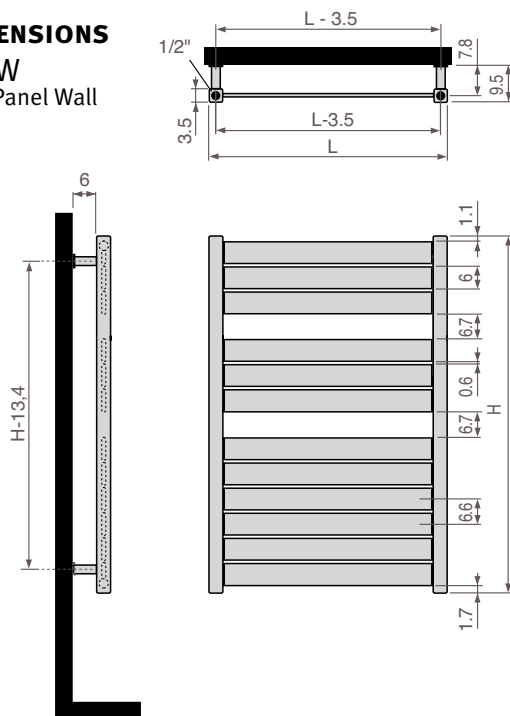

FIXINGS

STANDARD
WALL FIXING

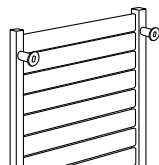

FOOT

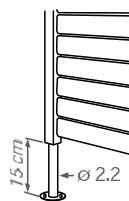

SIDE END
FIXING

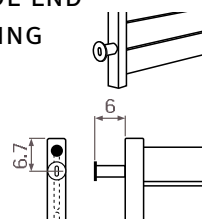

Configurations on size: see parts.

CONNECTIONS

Code: 1° number = flow
2° number = return

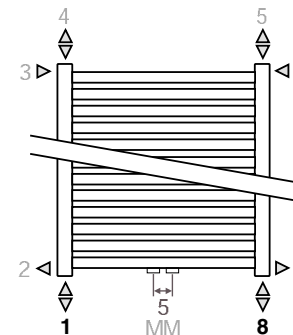

STANDARD CONNECTION:

Code 18
Connection 18 or 81

TOP END CONNECTION:

Ordering code: specify 45 or 54 instead of 18. Insert pipe included without surcharge, to be mounted in the return, provide an air vent on the central heating tube.

SIDE END CONNECTION:

Ordering code: specify 32, 67, 41 or 58 instead of 18, no surcharge.

ONE PIPE CONNECTION:

Ordering code: specify code 11 or 88 instead of 18.
In case of one pipe connection always use a diffusion tube of min. length of 100 mm (Ø 10 up to 12 mm) with a reduction washer. Not possible with a radiator on feet.

WITH ELECTRIC ELEMENT:

Standard code 18, and order an electric element. Not possible with a radiator on feet.



MIXED:

Standard code 18.

Order an electric element and T-pieces.

> Fit the T-piece together with the electrical heating element for connection to the central heating wet system.

> Never isolate the radiator from the expansion system, in other words never cut off the return of the radiator.

Not possible with a radiator on feet.

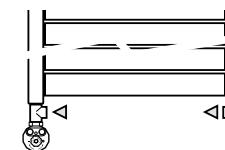

Non standard connections without surcharge



Product descriptions > Sani

SANI

MATERIAL

The radiators are composed of vertical steel collectors (35 x 35 x 1.5 mm) and horizontal steel radiation tubes, with open spaces to dry towels or linen. The radiation tubes are silver welded at the exterior part of the collector. An electrical heating element may be installed. For [central heating wet system](#) / [electric only](#) / [mixed application \(mixed\)](#).

COMPOSITION

> SANI RONDA

Round steel radiation tubes (ø 22 x 1.25 mm) placed at a distance of 15 mm.
Open space: 100 mm
The supports to fit to the wall are supplied with the standard delivery. These supports are fixed around the radiation tubes by Hexagon socket set screws.

> SANI PANEL

Oval steel radiation tubes (60 x 10.4 x 1.5 mm) placed at a distance of 6 mm.
Open space: 67 mm
The supports to fit to the wall are supplied with the standard delivery. These supports are fixed on the collectors by Hexagon socket set screws.

> SANI LOUVRE

Oval steel radiation tubes (60 x 10.4 x 1.5 mm) placed in an angle of 15° and at a distance of 3 mm.
Open space: see dimensions table.
The supports to fit to the wall are supplied with the standard delivery. These supports are fixed on the collectors by Hexagon socket set screws.

THE FINISH

The radiators are sandblasted, degreased, phosphated, electrostatically lacquered with epoxy-polyester powder and finally enamel stoved at 200 °C. This high quality finish offers an optimal scratch resistance and is very easy to maintain.
Thickness of the lacquer: min. 80 µ.

Pressure test: 9 bar
Working pressure: 6 bar

COLOUR

The radiators are lacquered in the colour [sandblast grey metallic 001](#) / [white \(RAL 9010\)](#) / [white \(RAL 9016\)](#) / [other \(see colour chart\)](#) / [chrome-plated \(only Sani Ronda\)](#).

CONNECTIONS

The sockets 1/2" are integrated at the top and bottom side end of the radiator.
The connections may be ordered at customer choice at top, bottom or at side end of radiator. Provided with a chrome-plated air vent 1/2" and drain cock 1/2".

Output in watts, measured in accordance with EN 442.

HOW TO INSTALL

The building services engineer chooses the radiators considering following conditions:

- > A heat output calculation according to the standard.
- > The heat output and the dimensions of the Sani radiators according to EN 442.
- > The radiators may be [wall fitted with the wall fixings supplied](#) / [fitted to the floor with 2 supplied feet and 2 supplied ceiling fixings](#) / [positioned perpendicular to the wall with 2 side end fixings left and 1 foot right](#) / [positioned perpendicular to the wall with 2 side end fixings right and 1 foot left](#)
- > The specially designed [thermostatic connection sets](#) / [thermostatic Jaga Deco](#) / [Jaga-Pro valves](#) / [manual Jaga Deco valves](#) can be connected to [plastic central heating service pipes](#) / [RPE/ALU. tube](#) / [copper tube](#) / [steel pipe](#).
- > [Jaga thermostatic heads](#) / [Jaga Deco thermostatic heads chrome](#) / [Jaga Deco thermostatic heads chrome/white](#) / [Jaga Comap thermostatic heads silver](#) / [not to be](#) / [to be fitted](#).

OPTIONS

- > Jaga Deco valves.
- > Electric heating element.
- > Electric heating element with infrared operation.
- > T-pieces for connection at the side end or at the back and for mixed application.
- > Insert pipe for top end connection

